



Rotron / Airscrew



Rotron AXIMAX[®] 3R Small Vaneaxial Fans

General Small Vaneaxial Information

Small Vaneaxial Fans are compact, high-speed fans whose airflow is parallel to the motor shaft. The impeller and guide vanes are of airfoil construction for maximum aerodynamic efficiency and minimum acoustical noise.

These fans are designed for use in tightly packaged airborne "black boxes" where sizes and weight must be held to an absolute minimum, where reliability is critical,

and where high heat loads must be dissipated with cooling air.

Small Vaneaxial Fans come in a variety of voltages and frequencies and are available with lead wires, terminal blocks and MS connectors. Most units are available with an optional internal Fan Performance Sensor (FPS) or an external Low Speed Warning Device (LSWD).

Rotron AXIMAX[®] 3R

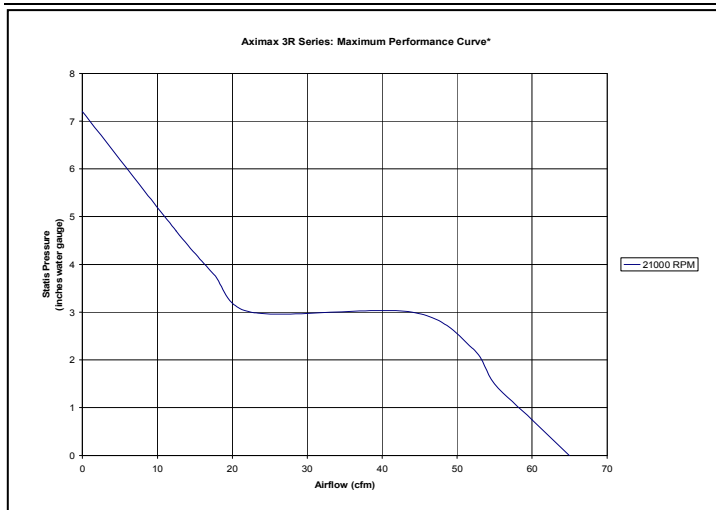

*Individual Performance Curve Characteristics Available Upon Request

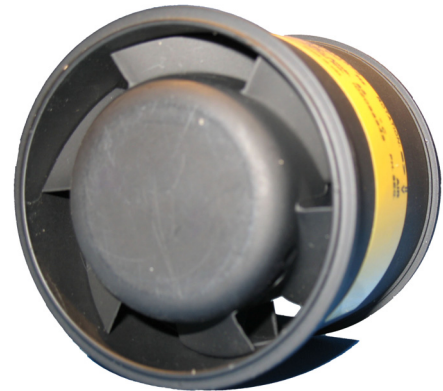

General

- Physical envelope: 2.94" Dia. x 3.120" L¹
- Weight: approximately 1.75 lbs.
- Specially designed for avionics cooling
- Custom mounting configurations, such as flanges or servo rings and synclamps, are available²

Materials and Finishes

- All aluminum components finished with a chemical conversion coating per MIL-C-5541, top coat of lusterless black enamel, color #37038, per Federal Standard 595 conforming to TT-E-489 Type B
- Corrosion-resistant stainless steel shaft and hardware
- Impeller runs on two high-precision, double-shielded, stainless steel ball bearings (ABEC Class 5) with an integral lubricant reservoir for a long, maintenance-free life
- Motors have stator winding insulation which is rated for continuous duty for Class H

¹ See specific part-number drawing for complete product dimensions

² Please contact the Application Engineering Department for further information

Options/Accessories

- Finger Guard
- Synclamp
- Custom Paints Available
- LSWD (Low Speed Warning Device)
- FPS (Fan Performance Sensor)



05-48

North America
T: +1 845-679-1361
F: +1 845-679-1870

www.ametekaerodefense.com

United Kingdom
T: +44 (0) 1932 765822
F: +44 (0) 1932 761098

Specifications subject to change without notice

Europe
T: +49 8145 951767
F: +49 8145 951768

Asia Pacific
T: +65 6484 2388
F: +65 6481 6588

Contact E-mail: mlinquiry@ametek.com



AC Line Powered Units¹

- 3-phase and 1-phase permanent-split capacitor motor designs
- Fixed speeds (performance) based on input frequency
- Meets or exceeds the requirements of MIL-B-23071 and other applicable U.S. military and commercial aerospace specifications²
- Max free delivery airflow of 92 CFM at 400 Hz
- Ambient temperature range: -54°C to 125°C
- Acoustic levels as low as 81.0 dBA

¹ Airflow, maximum ambient and acoustic levels will vary depending on design parameters

² Please call for further information concerning applicable U.S. military and commercial aerospace specifications

DC Powered Units - E.C.D.C.^{®1}

- Brushless permanent magnet design (Electronically Commutated DC)
- Speed (performance) fixed by input voltage
- Meets or exceeds the requirements of MIL-B-28873 and other applicable U.S. military and commercial aerospace specifications²
- Max free delivery airflow of 113 CFM
- Ambient temperature range: -54°C to 85°C
- Acoustic levels as low as 74.6 dBA

Optional DC-AC Inverters and AC-AC Converters for AC Powered Models¹

BATAC[®] Inverter Driven Units

- AC square wave fans driven from a DC power source through a BATAC[®] Inverter
- Low cost alternative when multiple fans are used in a single application or area
- Allows for greater than 100 VDC input voltage

¹ See Accessories: Power Conversion

DELTA[®] Converter Driven Units

- DELTA[®] converters allow high frequency (typically 400 Hz) fans to be driven by variable frequency (typically 360-800 Hz) power or low frequency 50/60 Hz power to obtain the higher frequency performance

Unit Description Key

The unit description key is for reference only and should not be confused with a part number. While most units are custom configurations, not all variations of the key shown below are possible. Please contact the Application Engineering department for more information regarding possible custom configurations.

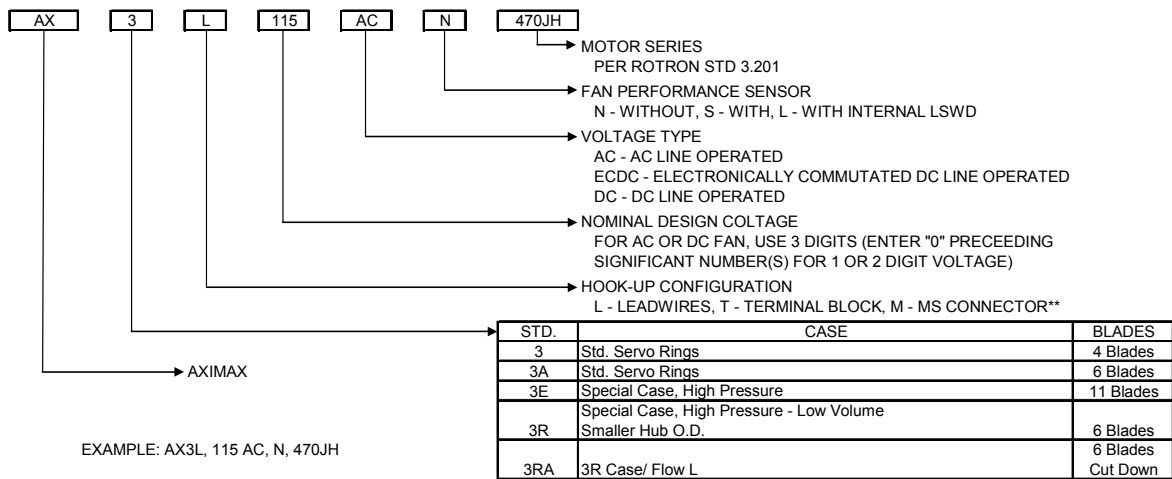

EXAMPLE: AX3L, 115 AC, N, 470JH

* "X" IN ANY POSITION DENOTES SPECIAL FOR THAT FEATURE
** TERMINAL BLOCK AND MS CONNECTOR NOT AVAILABLE ON AX3R/ 3RA

Ordering Information

When ordering, please specify the specific Rotron part number listed on the model table below. Further ordering information, based on the configuration and motor series, may be obtained by contacting customer service. Please refer to the Unit Description Key explanation above.



North America
T: +1 845-679-1361
F: +1 845-679-1870

United Kingdom
T: +44 (0) 1932 765822
F: +44 (0) 1932 761098

Specifications subject to change without notice

Europe
T: +49 8145 951767
F: +49 8145 951768

Asia Pacific
T: +65 6484 2388
F: +65 6481 6588

www.ametekaerodefense.com

Contact E-mail: mlinquiry@ametek.com



Rotron / Airscrew



Standard Product Offering of AC Line Powered Models

Part #	Prod. Desc.	Flow (CFM)	Max Pressure (IWG)	Nom. RPM	Nom. Watts	Line Amps (A)	Max Amb (C)	Weight	Volts	Phase	Hz	Capacitor	Airflow Source Data	Features
035724000	AX3RL 1033YH	64	6.7	20800	76	0.7	125	1.0	115	1	400	1.0/220	A163-10	LEADS, FPS
022172000	AX3RL 1034JH	63	7.1	21000	65	0.2	125	1.0	200	3	400	N/A	A368-9	LEADS

Standard Product Offering of DC Line Powered Models

Part #	Prod. Desc.	Flow (CFM)	Max Pressure (IWG)	Nom. RPM	Nom. Watts	Line Amps (A)	Max Amb (C)	Weight	Volts	Airflow Source Data	Features
012272000	AX3RAS 3845SF	98	3.6	22000	133	5.2	85	1.6	28	A711-19A	CONNECTOR, FPS, EMI FILTER
012107000	AX3RAMX 318SF	74	2.1	19600	94	3.3	85	1.5	28	A716-1	CONNECTOR, FPS

AXIMAX 3R – AC*

AX3RL

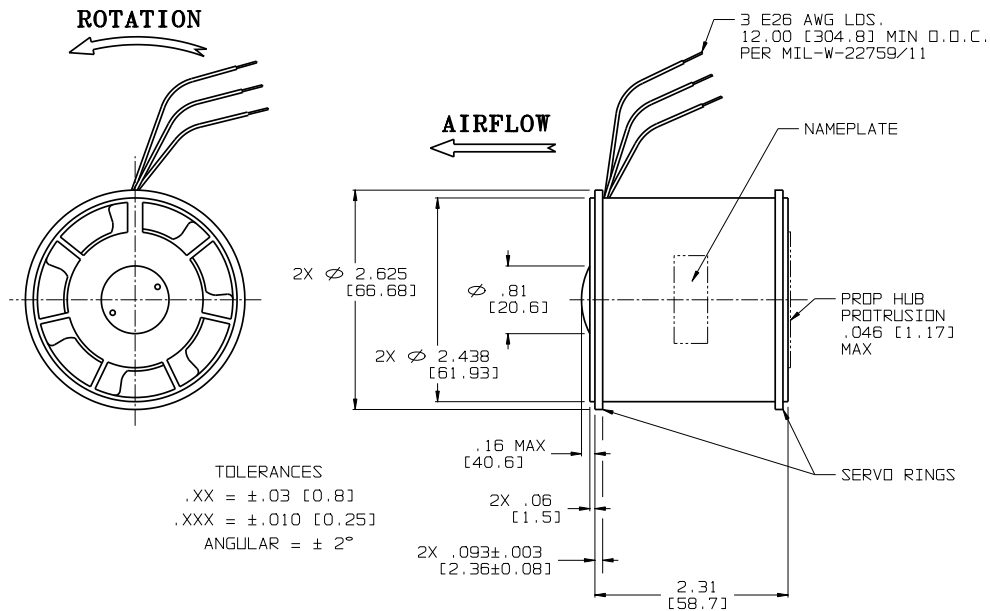

*Part Number Specific Drawings Available Upon Request

AMETEK
AEROSPACE & DEFENSE
Rotron / Airtechnology Products

North America
T: +1 845-679-1361
F: +1 845-679-1870

United Kingdom
T: +44 (0) 1932 765822
F: +44 (0) 1932 761098

Specifications subject to change without notice

Europe
T: +49 8145 951767
F: +49 8145 951768

Asia Pacific
T: +65 6484 2388
F: +65 6481 6588

www.ametekaerodefense.com

Contact E-mail: mlinquiry@ametek.com



Rotron / Aircrew



P/N 035724000 AX3RL 1033YH A163-10

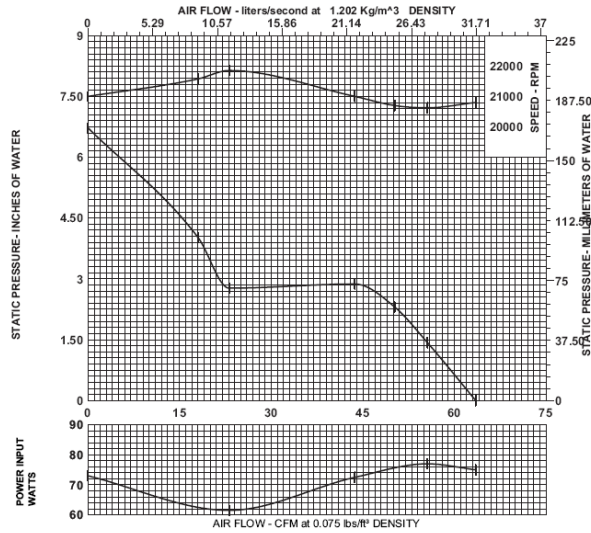

P/N 022172000 AX3RL 1034JH A368-9

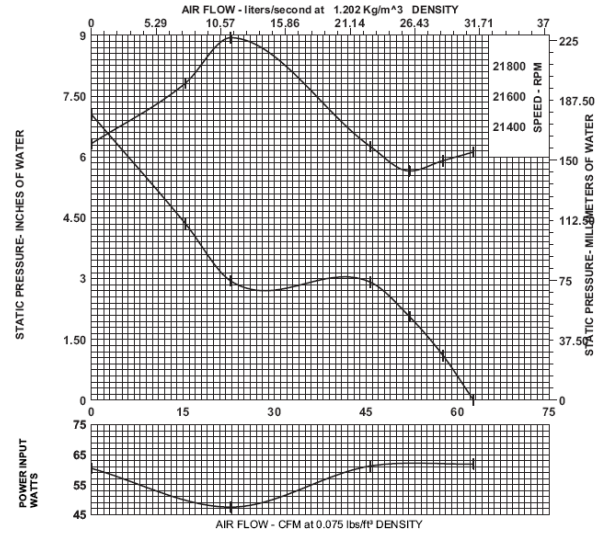

P/N 012272000 AX3RAS 3845SF A711-19A

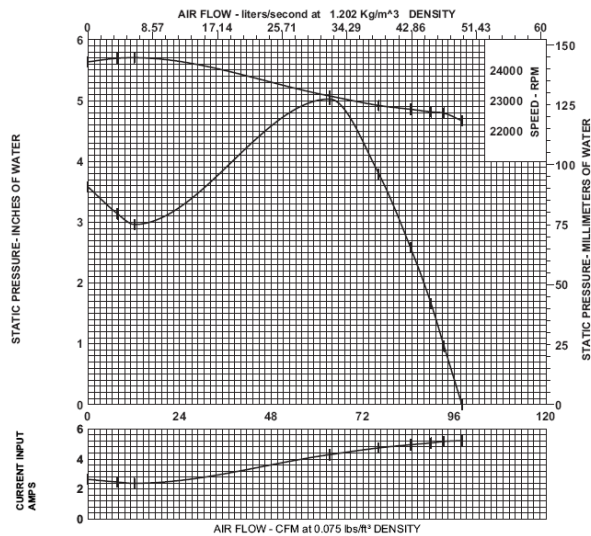

P/N 012107000 AX3RAMX 318SF A716-1

